

Aufbauanleitung  
Assembly Instructions

Garbage Bin  
Model Number:

HMSLGX4

Item Number #68814 ,#68815, #68816

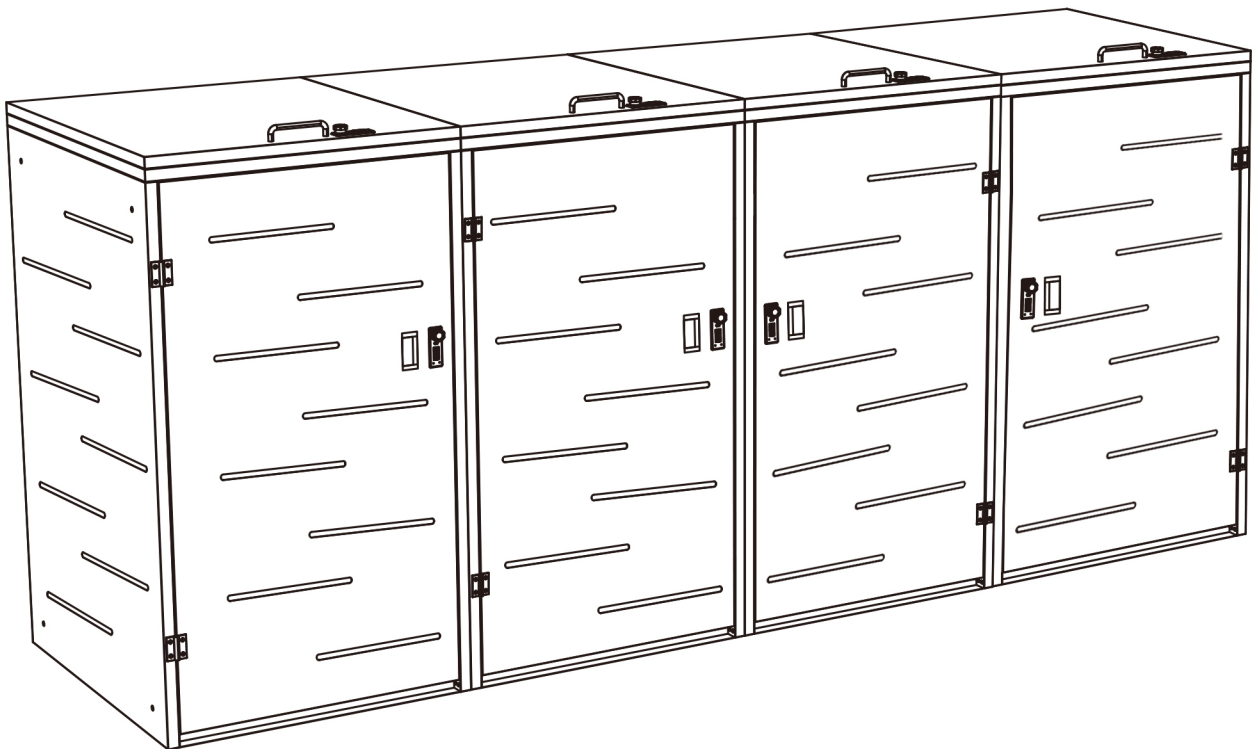

Mendler Vertriebs-GmbH  
Industriestr. 60  
73642 Welzheim

[fragen@heute-wohnen.de](mailto:fragen@heute-wohnen.de)

[www.heute-wohnen.de](http://www.heute-wohnen.de)

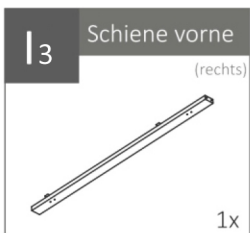
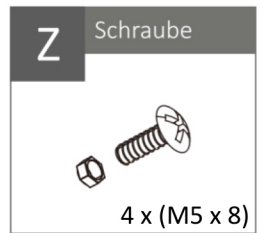
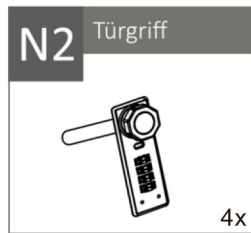
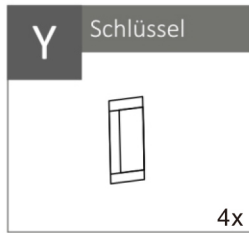
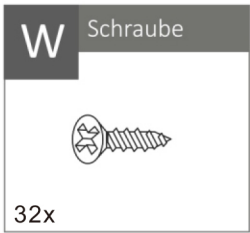
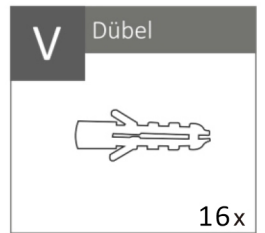
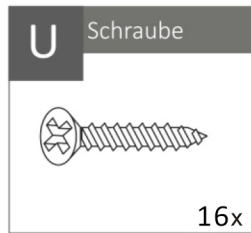
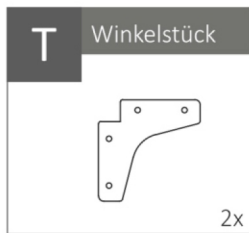
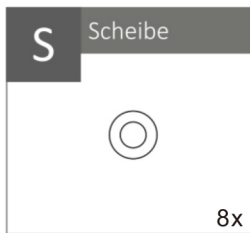
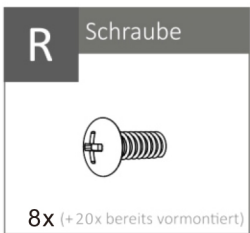
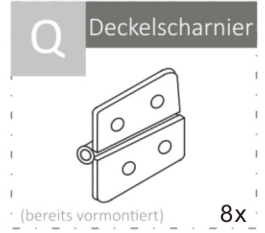
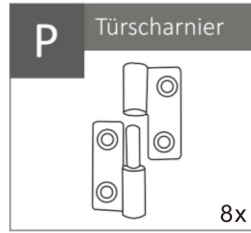
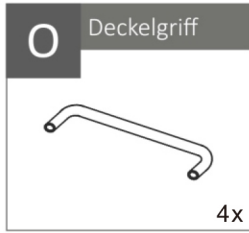
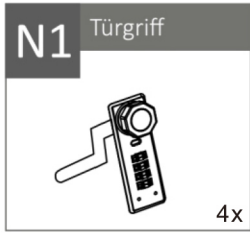
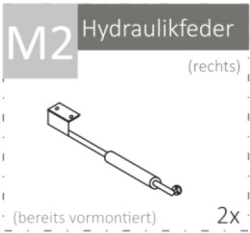
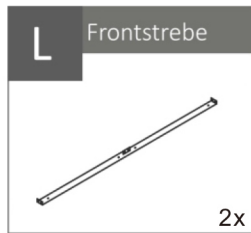
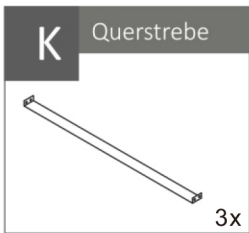
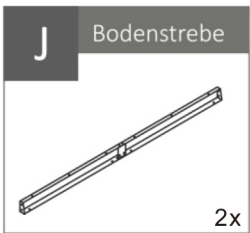
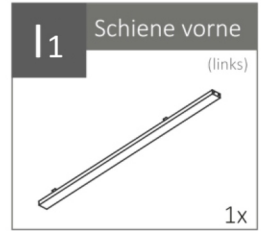
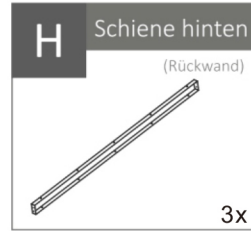
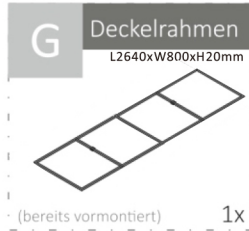
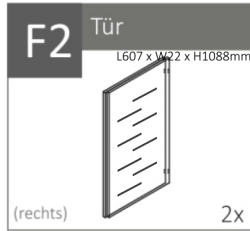
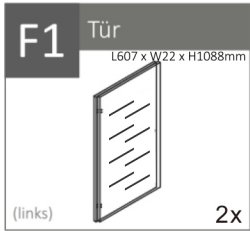
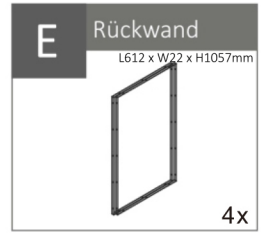
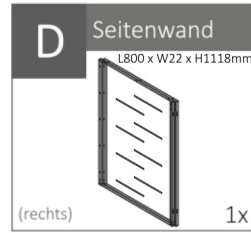
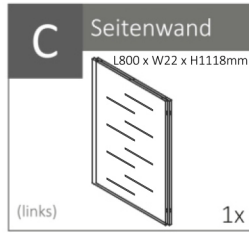
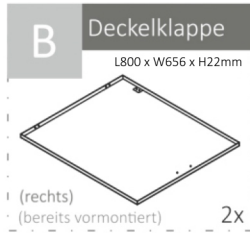
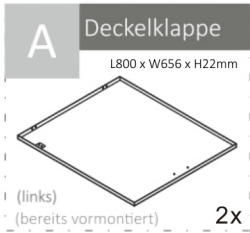

1

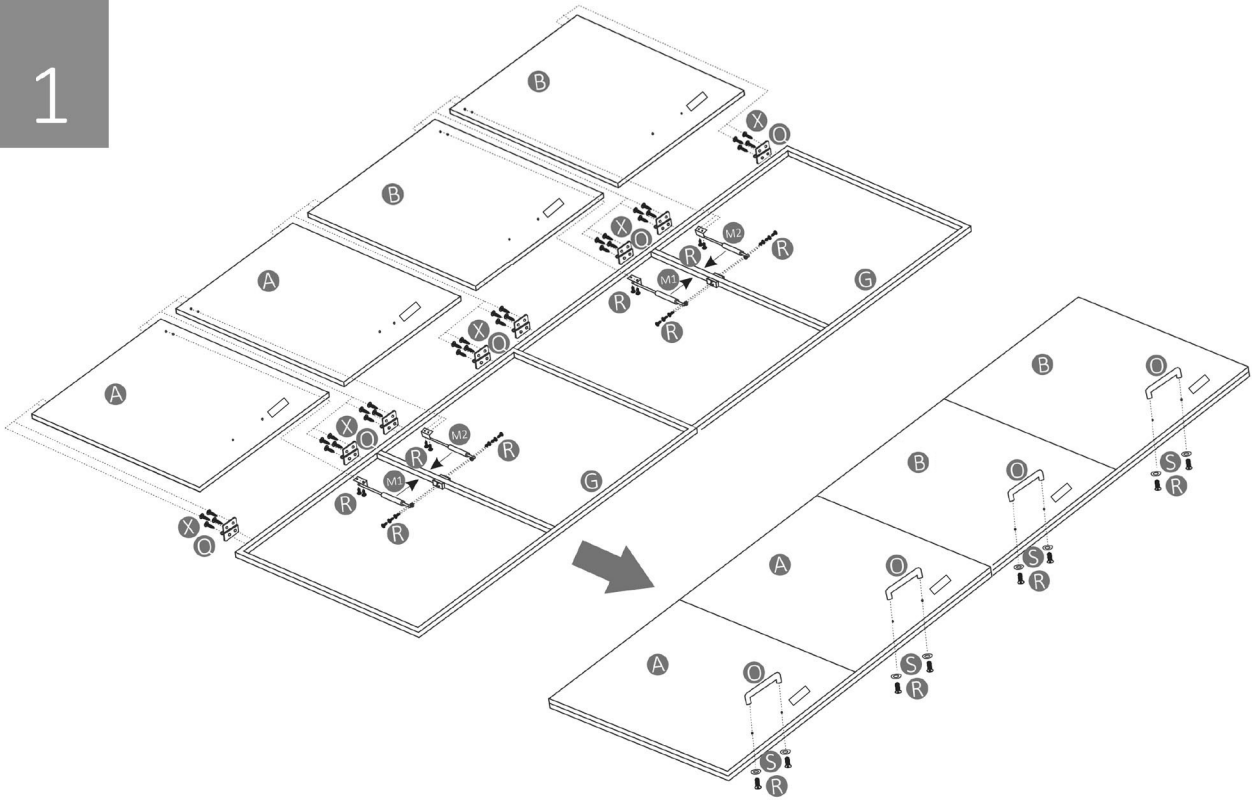

2

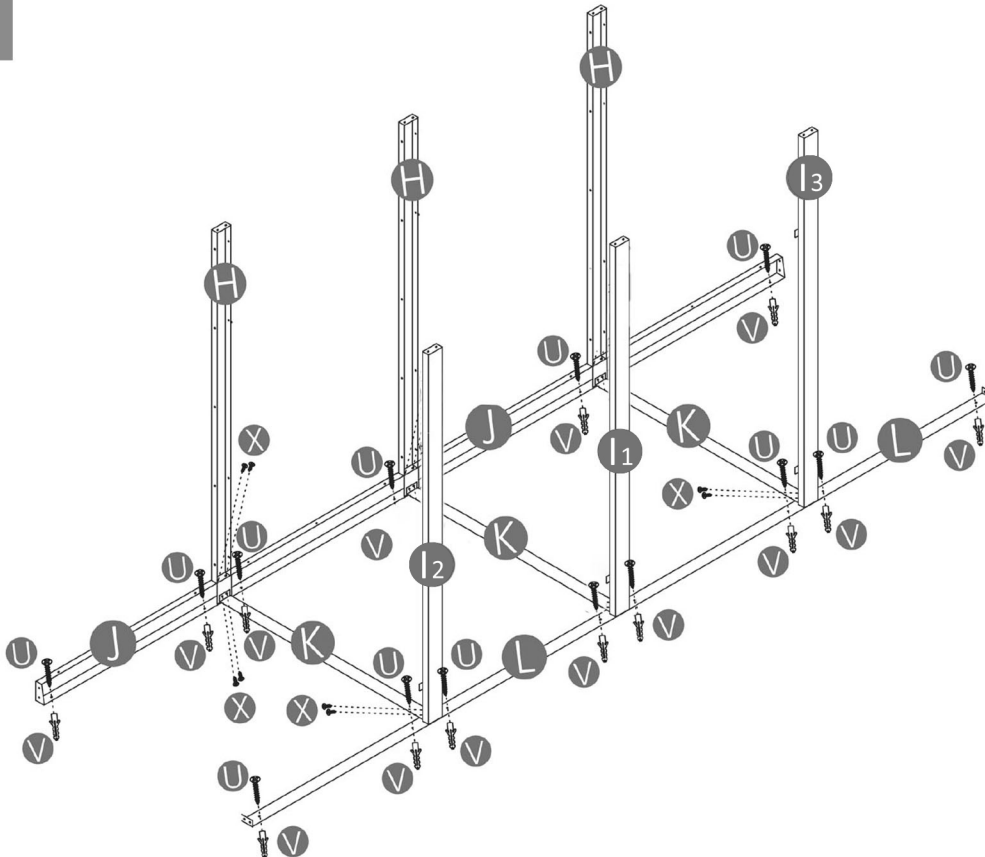

3

3

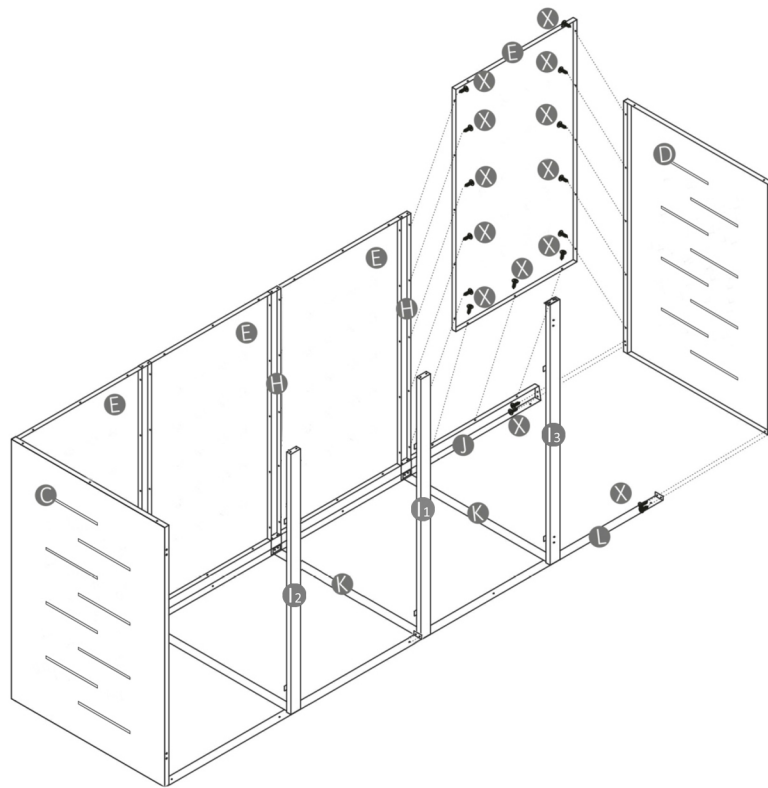

4

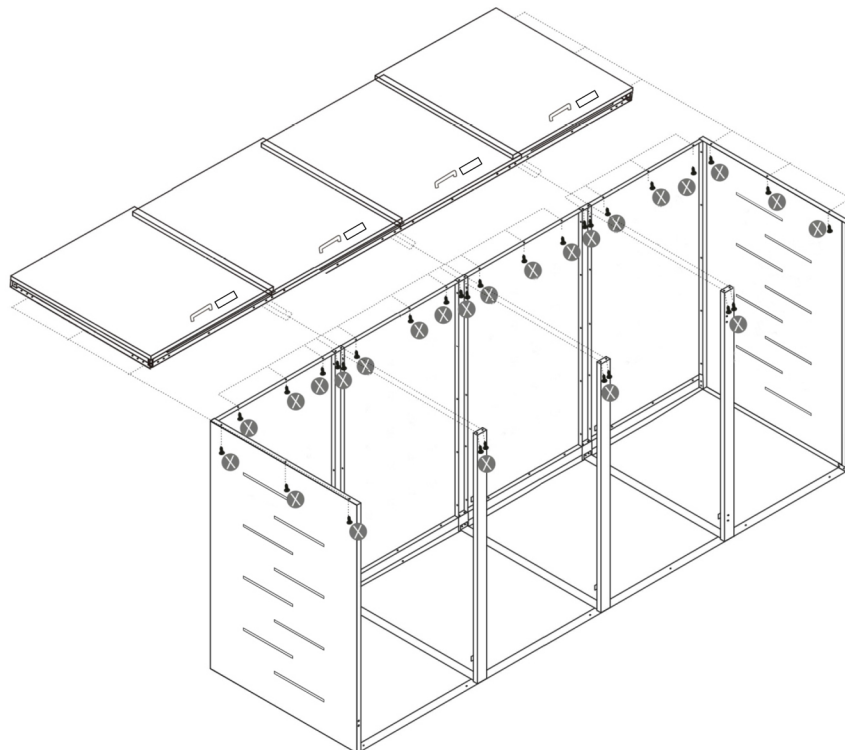

5

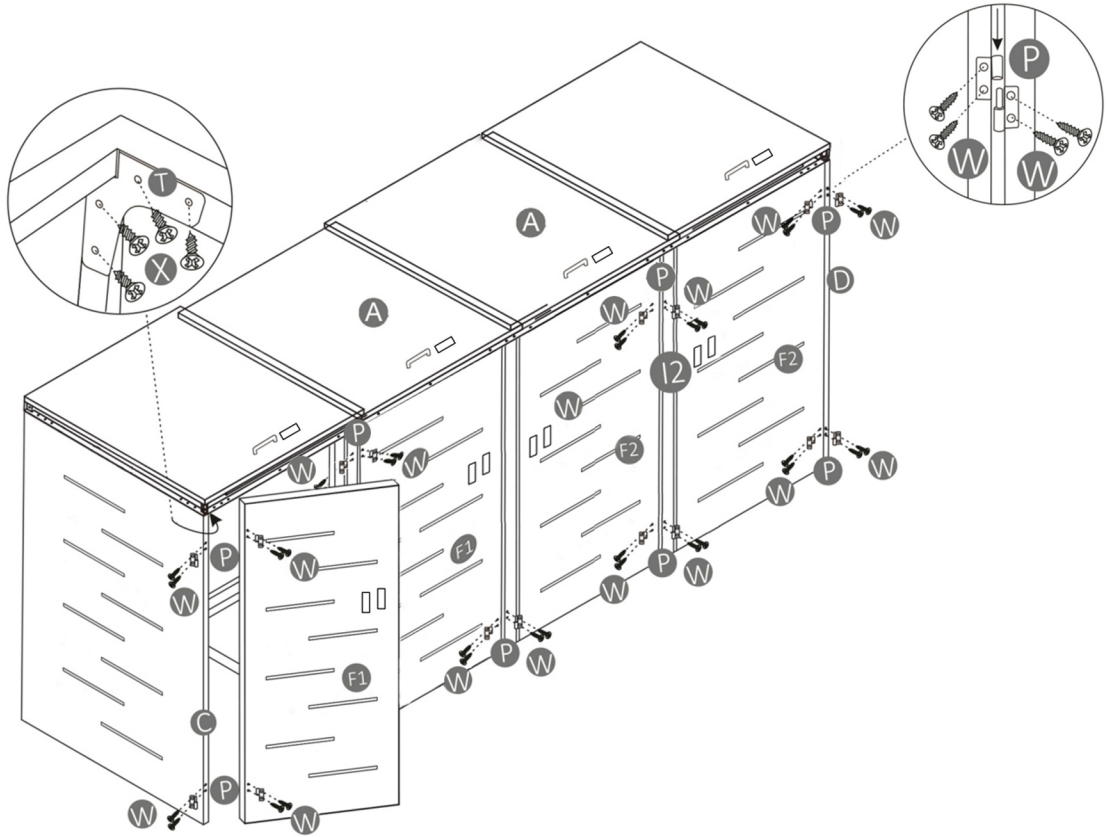

6

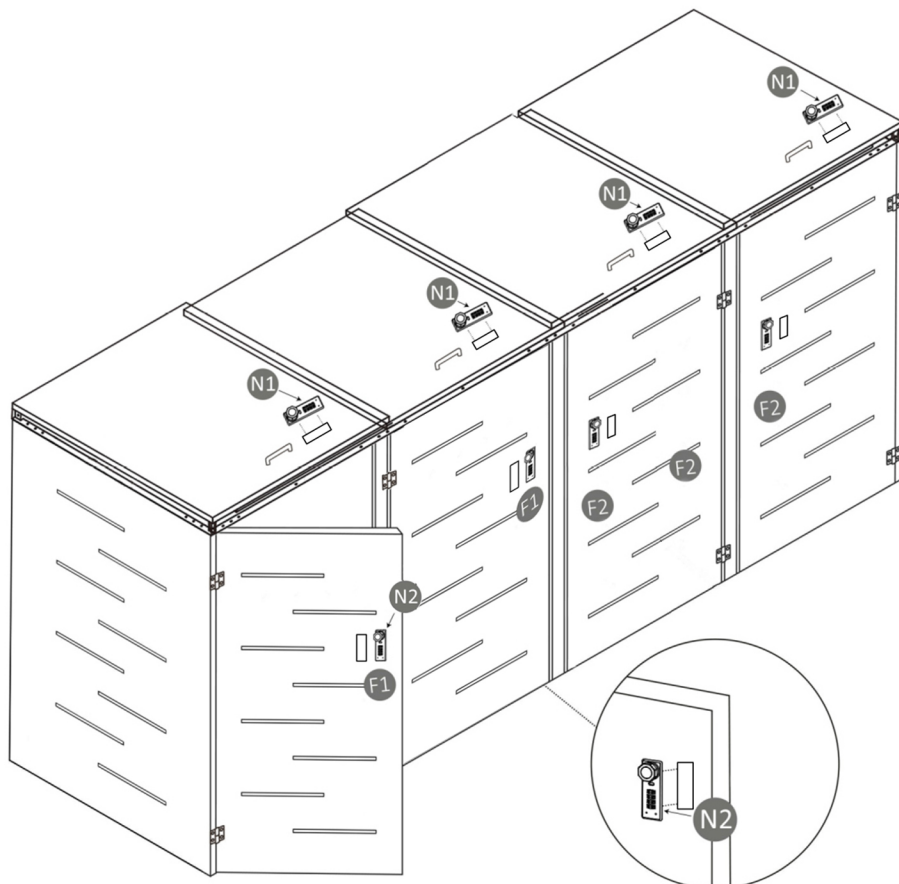

7

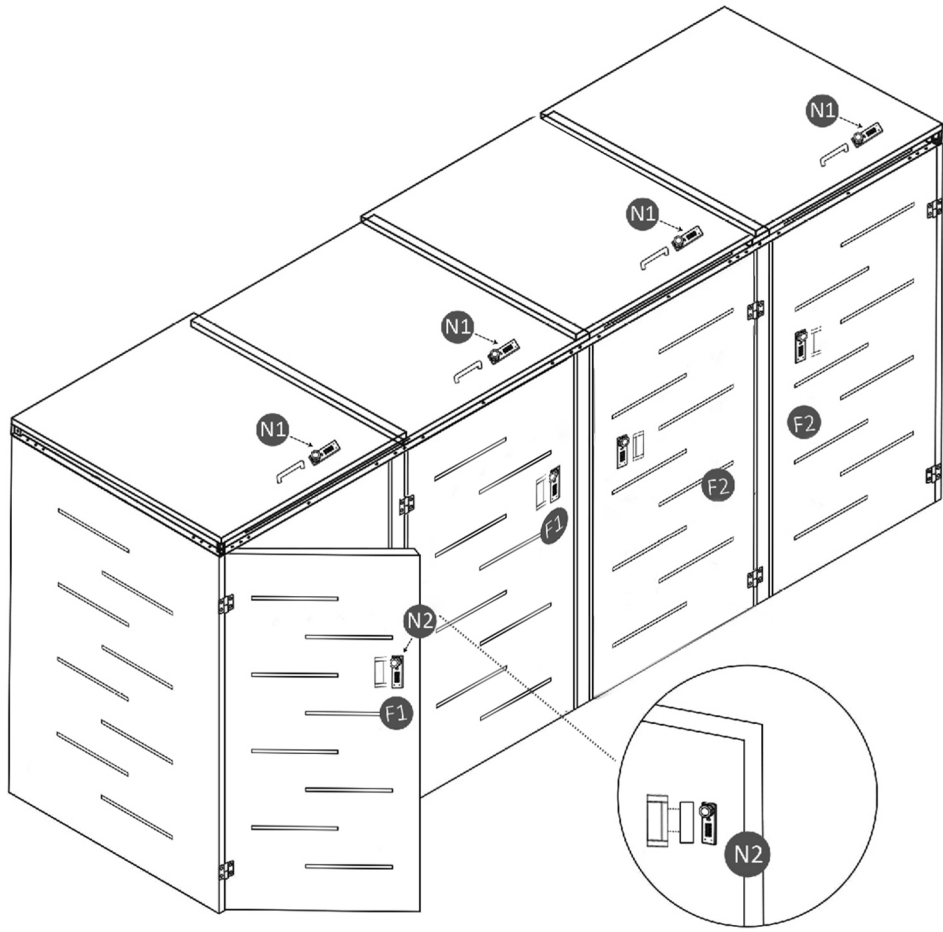

8

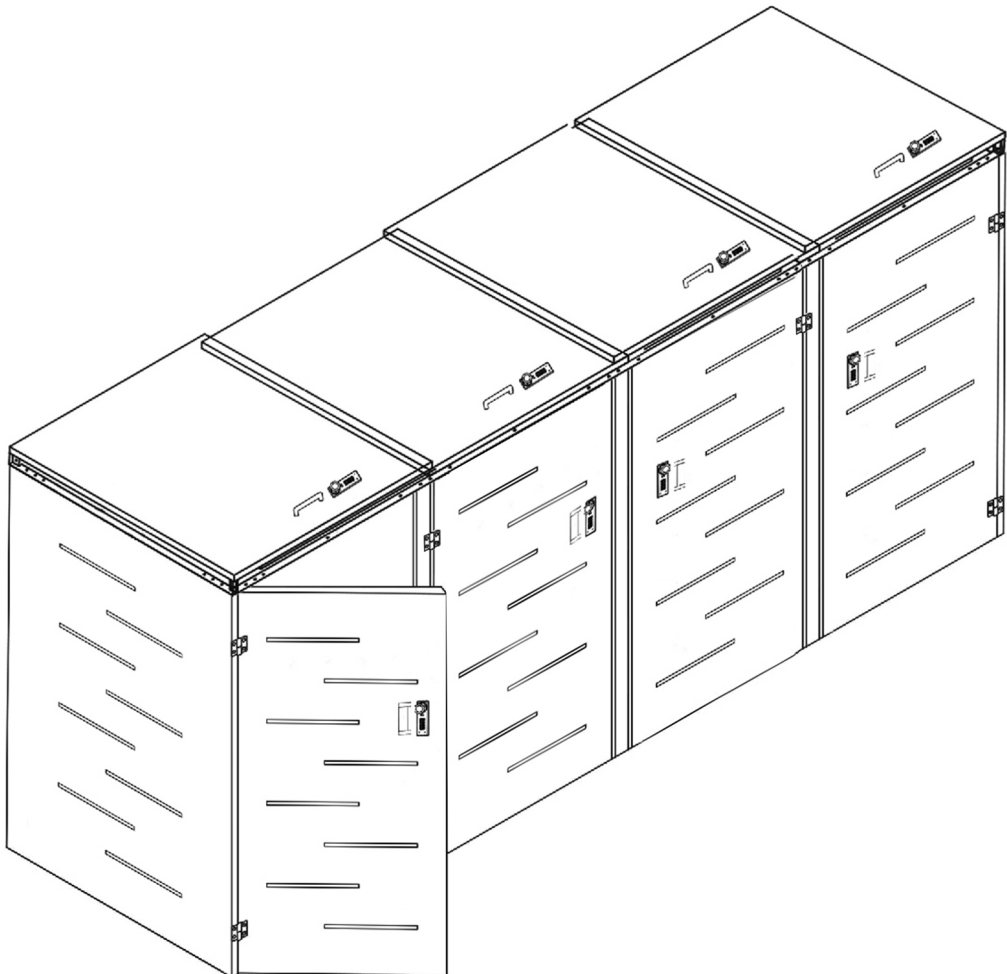

110

140



MECHANICAL LOCKER INSTRUCTION MANUAL

### 1. Lock & Unlock

1. ☹️ = CLOSE   
 ↓   
 5. 😊 = OPEN

2.   
 Turn the knob to close position

3.   
 input correct password to open

4.   
 Turn the knob to OPEN position

5. OPEN   
 ! Door open. But at OPEN position, you can not change password

### 2. Password changing

6. = 0|0|0|0   
 ↓   
 10. 😊 = 1|6|8|8   
 Default password: 0-0-0-0

7.   
 1.PERSONAL   
 2.PUBLIC   
 3.CODE RESET   
 Front side   
 Back side   
 Turn knob to "OPEN" position, and back side button to 2 PUBLIC mode

8.   
 Turn the knob to CHANGE position

9.   
 10. = 1|6|8|8 = ✓   
 ! change your password

### 3. Password changing at private mode

11. ☹️ = 1|6|8|8   
 ↓   
 15. 😊 = 8|8|8|8   
 Current password: 1-6-8-8

12.   
 1.PERSONAL   
 2.PUBLIC   
 3.CODE RESET   
 Front side   
 Back side   
 Turn knob to "OPEN" position, and back side button to 2 PUBLIC mode

13.   
 Turn the knob to CHANGE position

14.   
 1.PERSONAL   
 2.PUBLIC   
 3.CODE RESET   
 Front side   
 Back side   
 Turn knob to "CLOSE" position, and back side button to 1 PERSONAL mode

15. = 8|8|8|8 = ✓   
 ! Password can not be changed

### 4. Password finding by emergency key

16. ☹️ = ☹️ ☹️ ☹️ ☹️   
 ↓ +   
 18. 😊 = ☹️ ☹️ ☹️ ☹️

17.   
 Turn the digit wheel one by one till wheel can not move

19. !   
 19.1   
 19.2   
 19.3

20.   
 1.PERSONAL   
 2.PUBLIC   
 3.CODE RESET   
 Front side   
 Back side   
 ! at PERSONAL mode, password can't be found by emergency key

### 5. Password finding by emergency bar

21. ☹️ = ☹️ ☹️ ☹️ ☹️   
 ↓ +   
 24. 😊 = ☹️ ☹️ ☹️ ☹️

22.   
 Hold the bar   
 Turn the digit wheel one by one till wheel can not move

23.   
 ☹️ ☹️ ☹️ ☹️   
 !

24.

Note: This step can be operated only when the door is open.





MECHANICAL LOCKER INSTRUCTION MANUAL

## 1. Öffnen und Schließen

1. ☹️ = schließen 🔒  
↓  
5. 😊 = öffnen 🔓

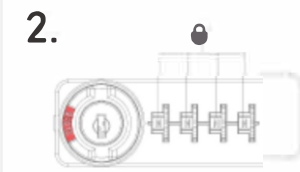

Drehknopf auf "open" drehen

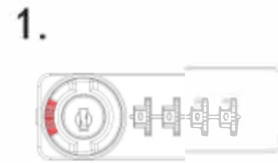

1. Drehen Sie den Drehknopf auf "close"



3. korrektes Passwort zum Öffnen eingeben



5. **offen**  
! Tür ist geöffnet, im offenen Zustand kann das Passwort nicht geändert werden

## 2. Passwort ändern

6. 0000  
↓  
10. 😊 = 1688



7. Frontseite Rückseite  
Drehen Sie den Drehknopf zu "open" und auf der Rückseite auf "2 Public"

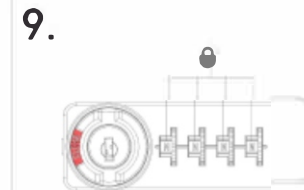

9.

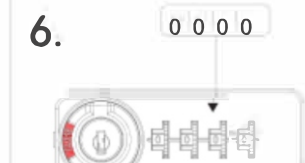

6. voreingestelltes Passwort 0-0-0-0











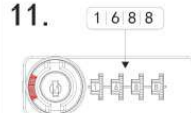

8. stellen Sie den Drehknopf auf "change"



10. **ändern Sie ihr Passwort**

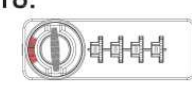
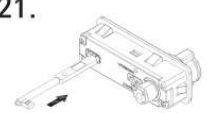
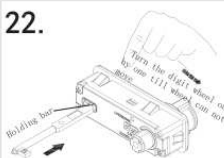

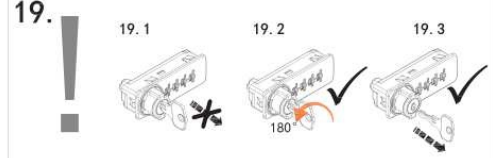
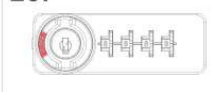
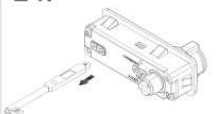
<b>3. Passwort ändern im Private mode</b>		<b>4. Passwort mithilfe des Notfallschlüssels eingeben</b>		<b>5. Passwort mithilfe des Notfallstabs eingeben</b>	
<b>11.</b> ☹️ = 1 6 8 8 ↓ <b>15.</b> 😊 = 8 8 8 8	<b>11.</b> 1 6 8 8 ↓  derzeitiges Passwort 1-6-8-8	<b>16.</b> ☹️ = 3 5 7 9 6 4 7 0 ↓ +  <b>18.</b> 😊 = 8 8 8 8	<b>16.</b> 16.1 ↓ 16.2 	<b>20.</b>  <b>Frontseite</b> auf "Personal mode" <b>Rückseite</b> auf "Public mode" ! Passwort nicht mit dem Schlüssel gefunden werden	<b>21.</b> ☹️ = 3 5 7 9 6 4 7 0 ↓ +  <b>24.</b> 😊 = 8 8 8 8
<b>12.</b>  <b>Frontseite</b> auf "open" <b>Rückseite</b> auf "2 Public mode"	<b>13.</b> 8 8 8 8 Drehen Sie den Drehknopf auf "change" 	<b>17.</b>  Drehen Sie die Drehfelder, eines nach dem Anderen, bis es sich nicht mehr bewegt	<b>18.</b>  😊 = 8 8 8 8 !	<b>21.</b> 	<b>22.</b>  Baldige bar Then the dial wheel can be open still when you rotate
<b>14.</b>  <b>Frontseite</b> auf "close" <b>Rückseite</b> auf "1 Personal mode" Dieser Schritt kann nur mit geöffneter Tür durchgeführt werden	<b>15.</b> 8 8 8 8 = ✓ ! Passwort kann nicht geändert werden	<b>19.</b> 19.1 ✗ 19.2 ✓ 19.3 ✓ 	<b>23.</b>  😊 = 8 8 8 8 !	<b>24.</b> 	

Note: The lock can be stuck in directly.  
 Note: If you want to connect the similar garbage bin, please use the part Z.