

ASSEMBLY INSTRUCTIONS

A*1

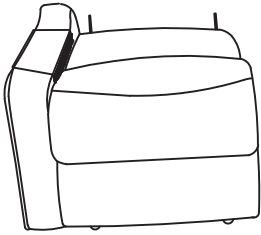

B*1

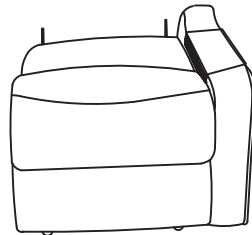

C*1

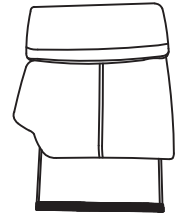

D*1

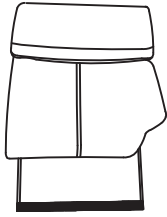

E*2

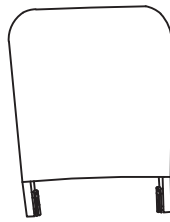

F*1

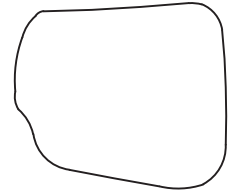

G*1

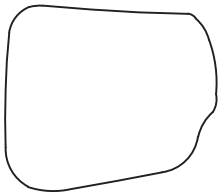

H*1

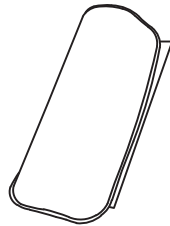

I *1

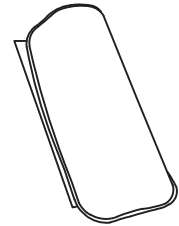

STEP 1:

A

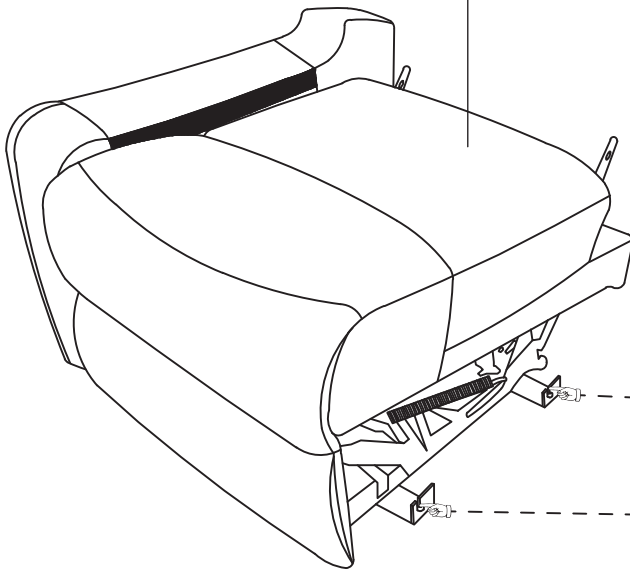

B

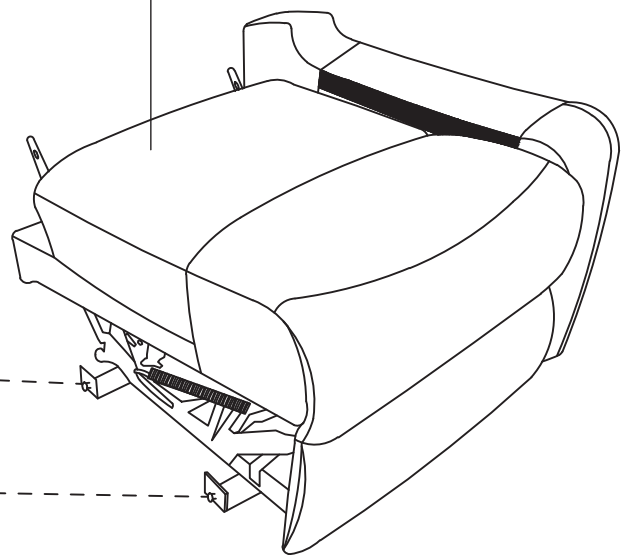

STEP 2:

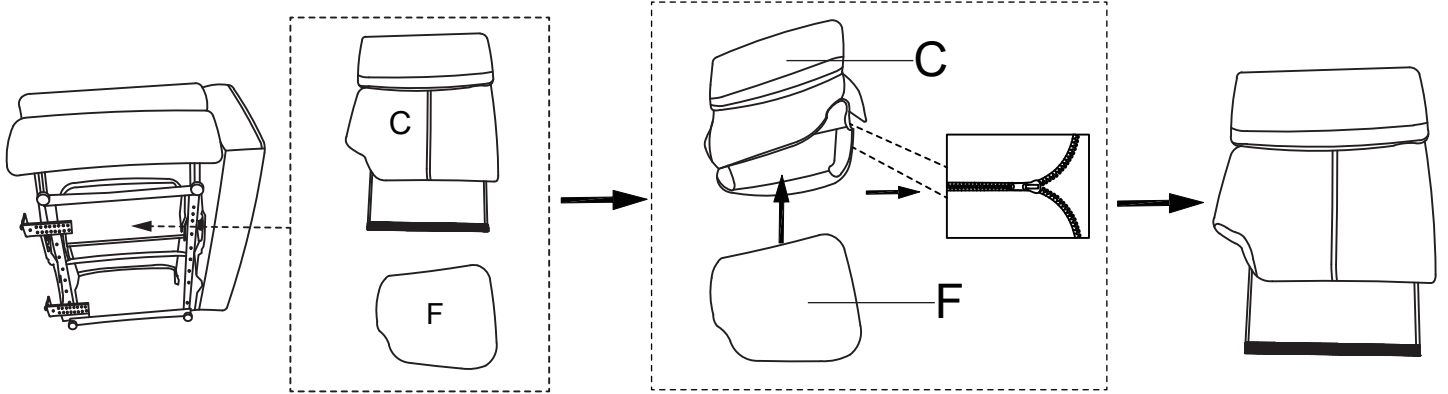

STEP 3:

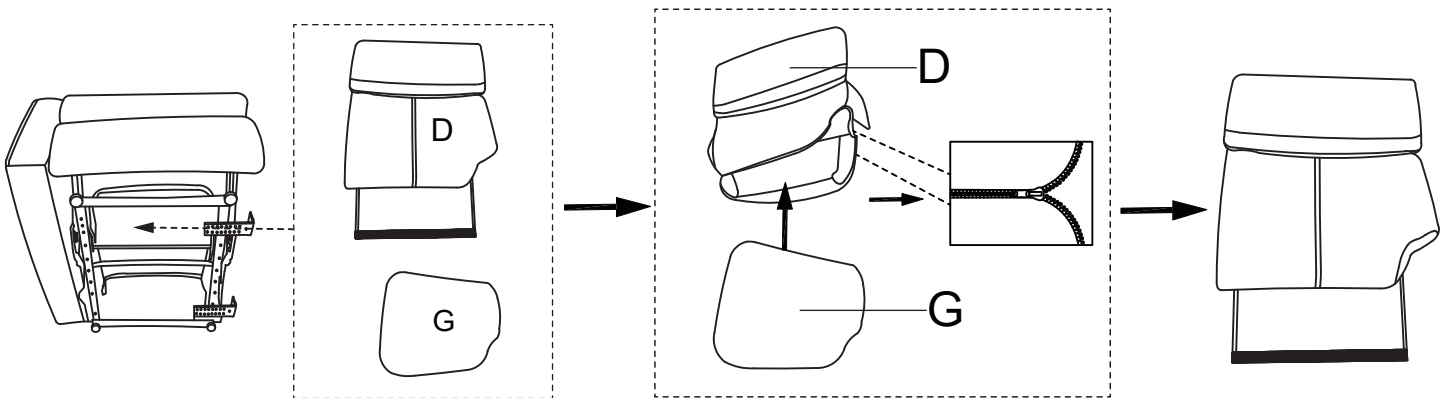

STEP 4:

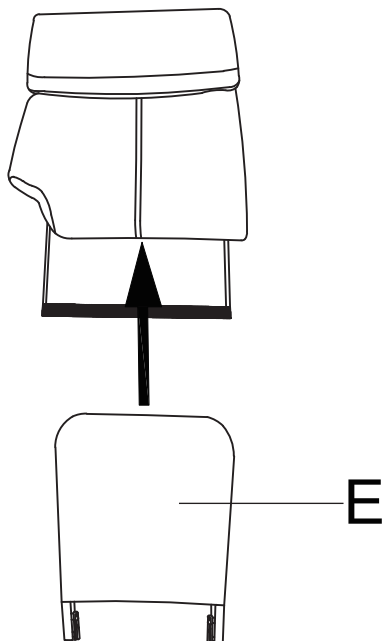

STEP 5:

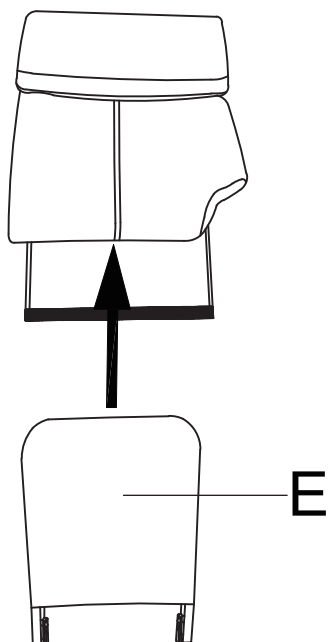

STEP 6:

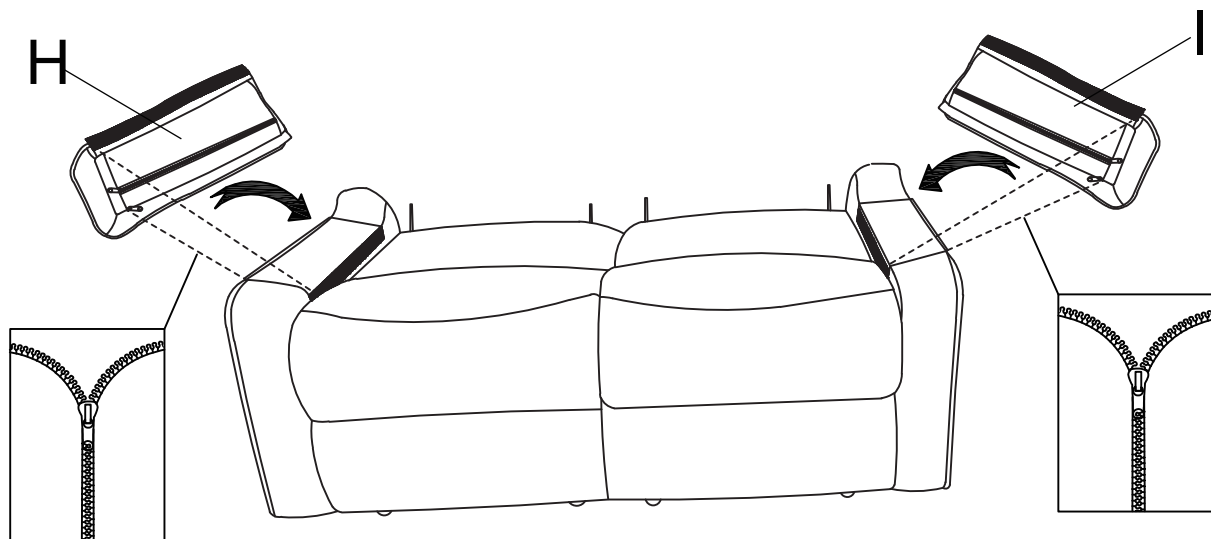

STEP 7:

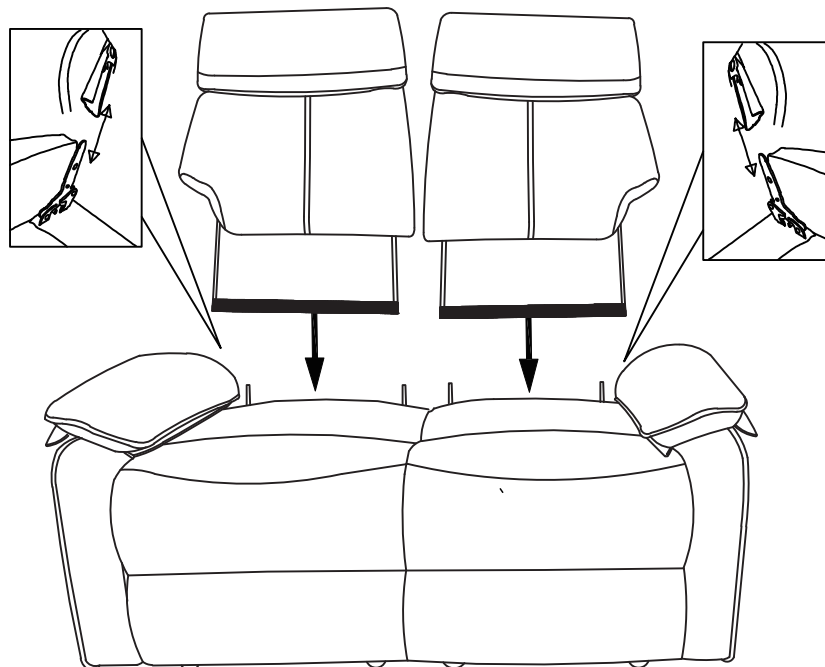

STEP 8:

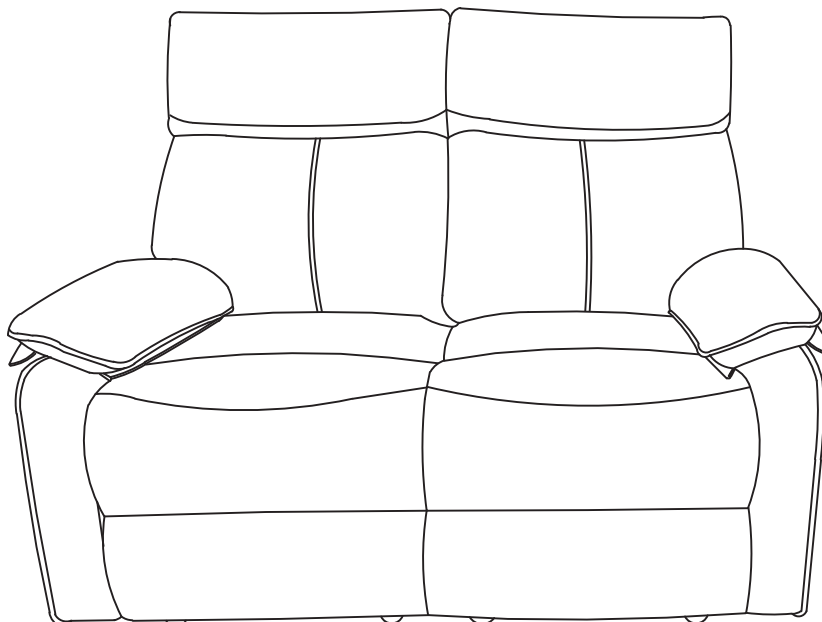

STEP 9:

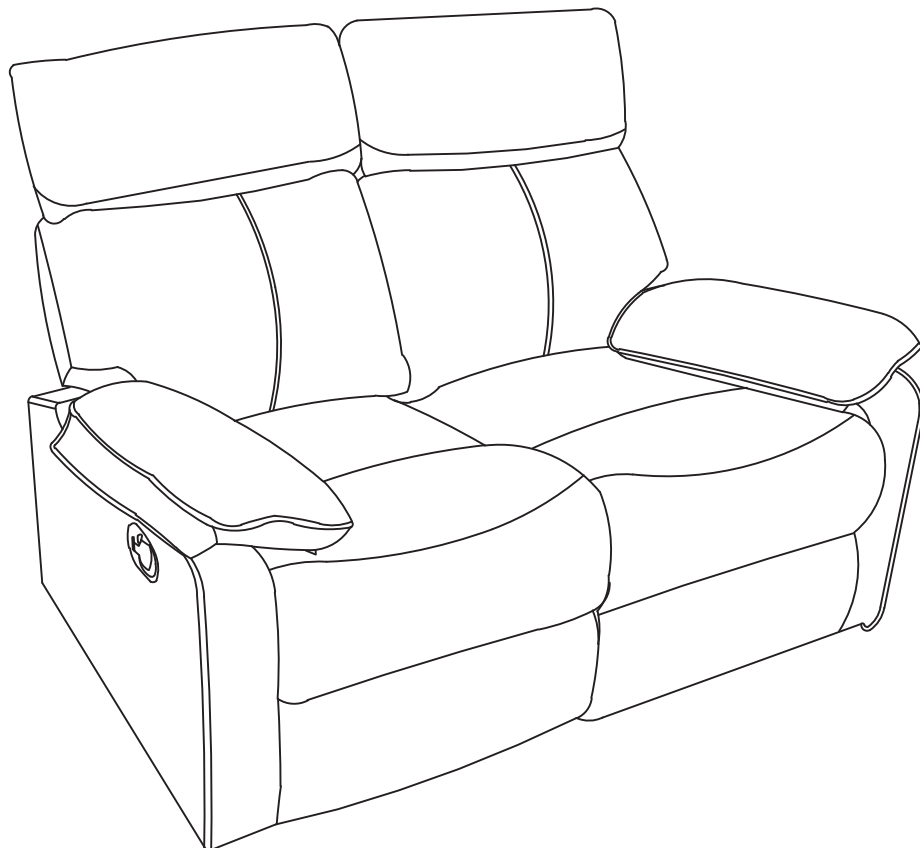

STEP 10:

